

- ✓ A classic for the prep station
- ✓ Delivered ready for installation
- ✓ 2x 360° booms on one stem

The dual ceiling boom is most efficient when installed in the pre-wash section of a tunnel wash or outside a self-service car wash for caravans. This is the area where they are most frequently used. If used in a self-service car wash, we recommend to connect the brush lance to the upper boom and the high pressure lance to the lower boom.

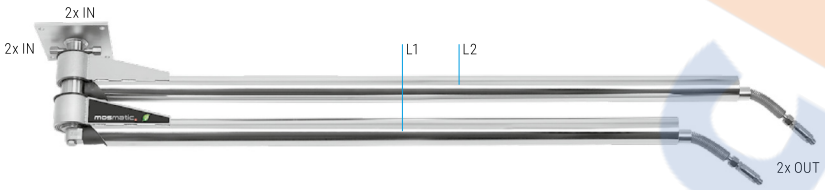
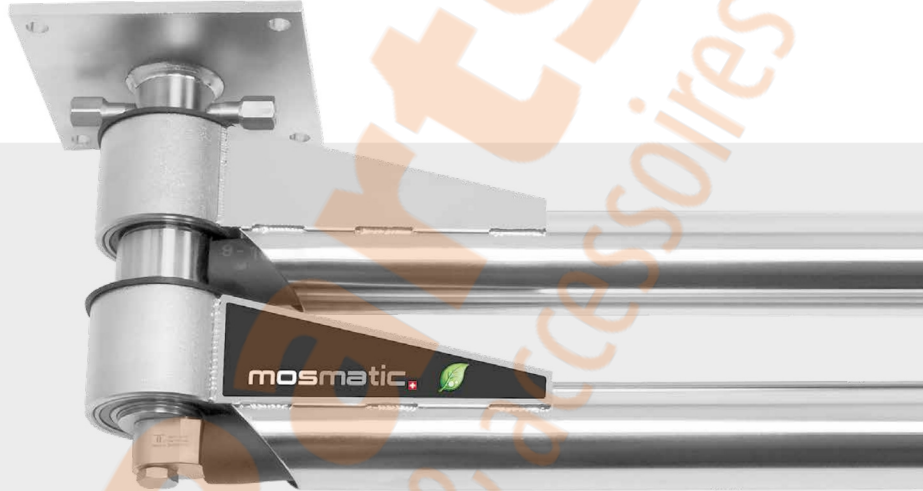

### DDP

Part No.	L1	L2	Weight
67.403	1450	1600	18.6 kg
67.413	1600	1750	18.9 kg
67.423	1750	1900	19.2 kg
67.433	1900	2050	19.5 kg
67.443	2050	2250	19.8 kg
67.453	2250	2500	21.1 kg

When using high and low pressure, we recommend to connect the low pressure to the upper boom.

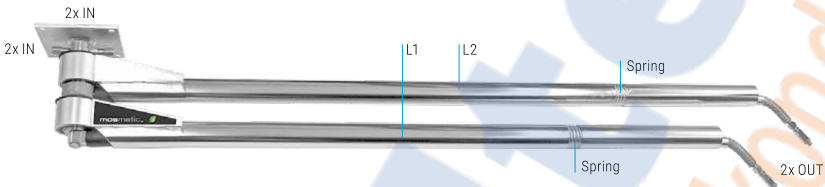

### DDF (with flex-arm)

Part No.	L1	L2	Weight
63.403	1450	1600	18.1 kg
63.413	1600	1750	18.8 kg
63.423	1750	1900	19.3 kg
63.433	1900	2050	20.5 kg
63.443	2050	2250	22.3 kg
63.453	2250	2500	23.5 kg

When using high and low pressure, we recommend to connect the low pressure to the upper boom.

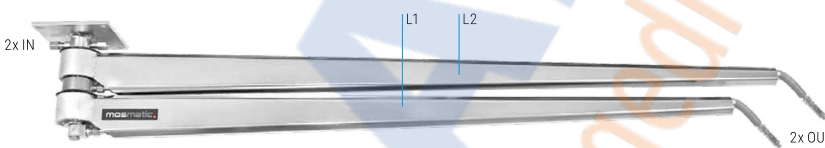

### DDK (hexagon shape, HP-hose)

Part No.	L1	L2	Weight
64.021	1450	1600	19.2 kg
64.001	1600	1750	19.5 kg

When using high and low pressure, we recommend to connect the low pressure to the upper boom.

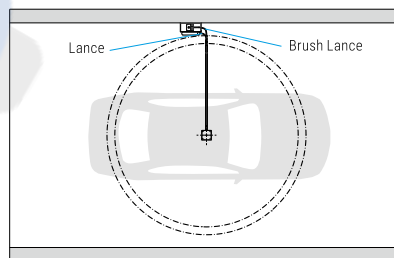
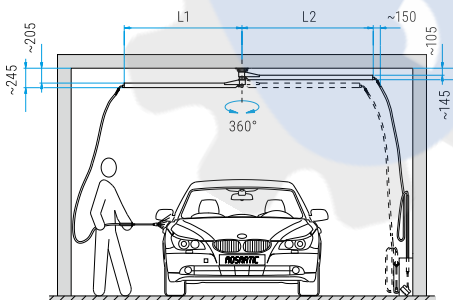
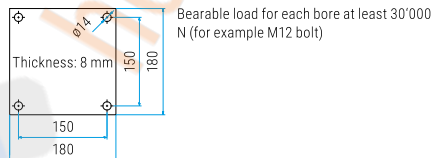

### TECHNICAL DATA

<b>Pressure</b>	275 bar (27.5 MPa)
<b>Temperature</b>	120°C
<b>Inlet (top &amp; side)</b>	G1/4" F (other options available)
<b>Outlet</b>	G1/4" M (other options available)
<b>Throughput medium</b>	water, oil, air at pH 3-12

 environmentally friendly products

### Legend

M., = metric thrust, ..M = male, F = female, G = gas pipe thrust, R = gas pipe thrust conical, QV = quick connects, SV = profile ring fitting  
D = diameter, L = length, NW = nominal width, SW = wrench size, IN = media input, OUT = media output, RS = basic position