

**DIMENSIONI D'INGOMBRO – OVERALL DIMENSIONS – DIMENSIONS D'ENCOMBREMENT
RAUMBEDARF – DIMENSIONES TOTALES – DIMENSÕES**

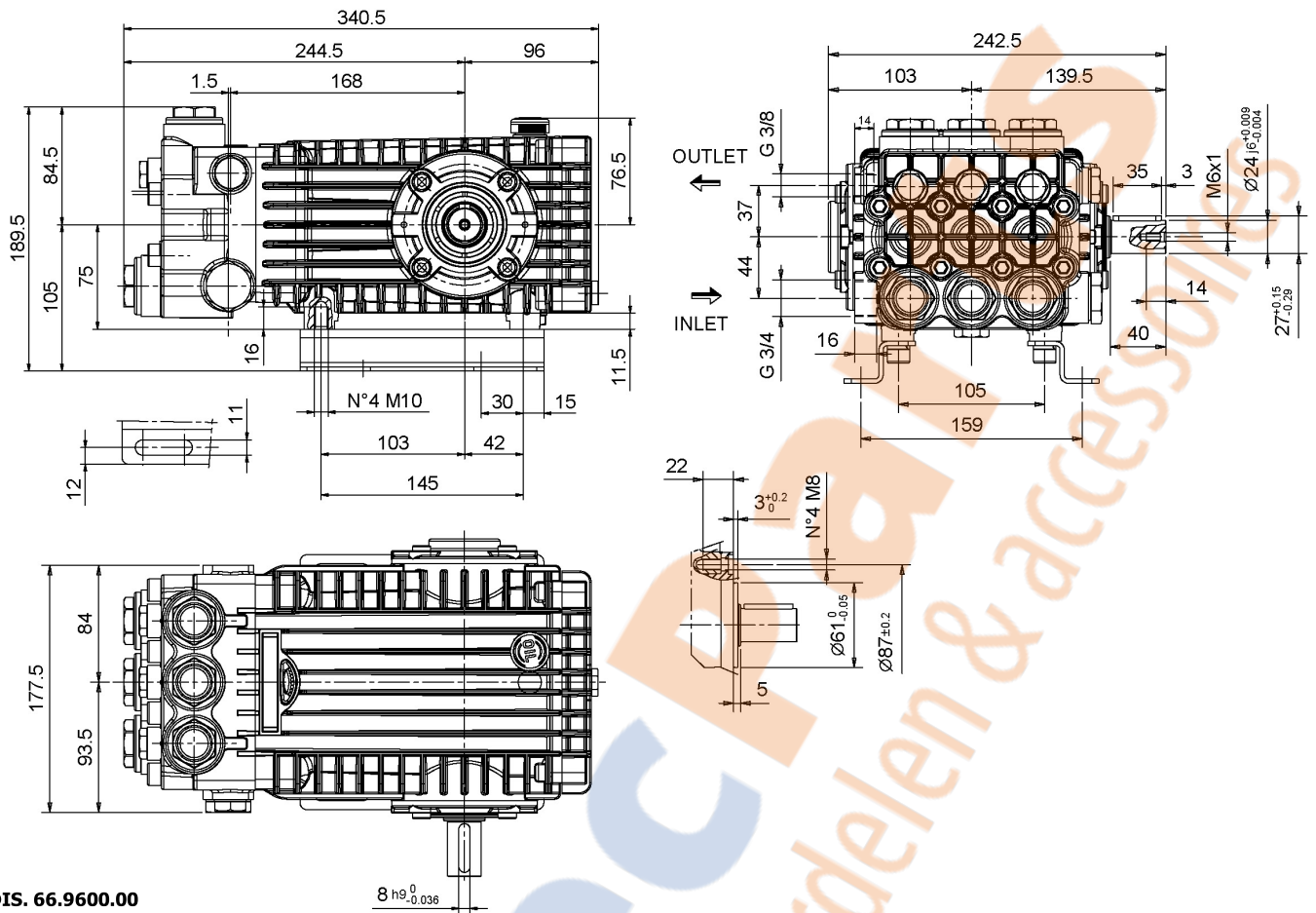

COD. DIS. 66.9600.00

**Coppia max. trasmissibile dal 2° PTO – Max. torque from 2° PTO
Couple max. transmissible du 2° PTO - Drehmoment transmissible max. von 2° PTO
De par max. de transmissible de 2° PTO – Binário máx. de transmissible de 2° PTO
33 Nm (5 kW@1450 rpm – 6 kW@1750 rpm)**

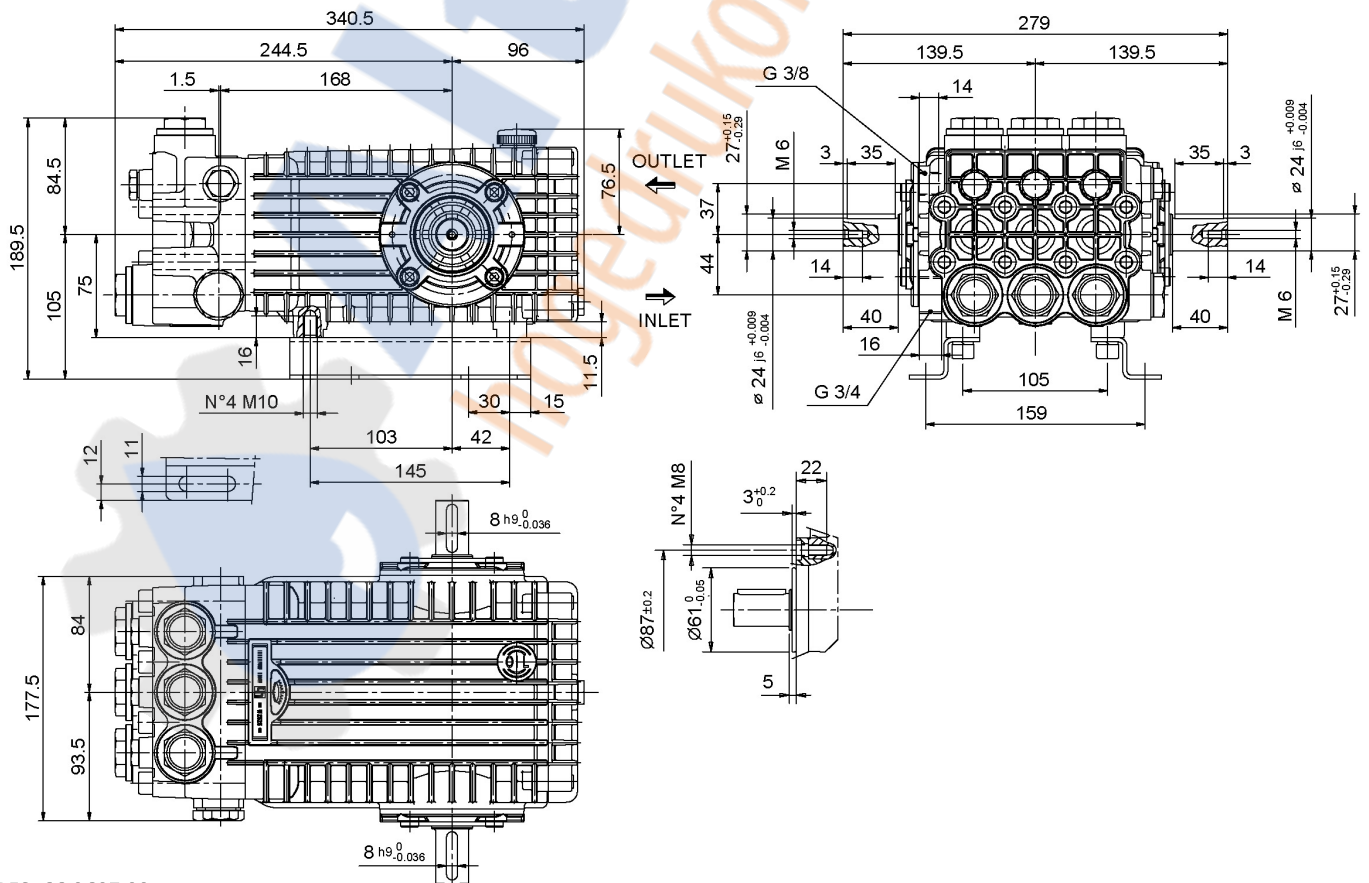

COD. DIS. 66.9605.00