

**DIMENSIONI D'INGOMBRO – OVERALL DIMENSIONS – DIMENSIONS D'ENCOMBREMENT
RAUMBEDARF – DIMENSIONES TOTALES – DIMENSÕES**

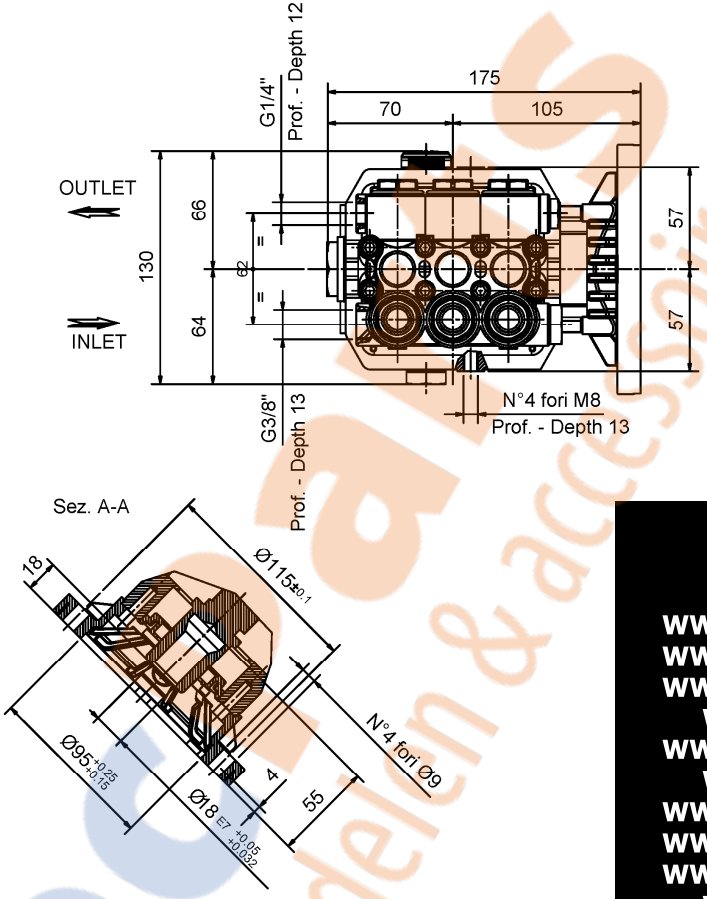
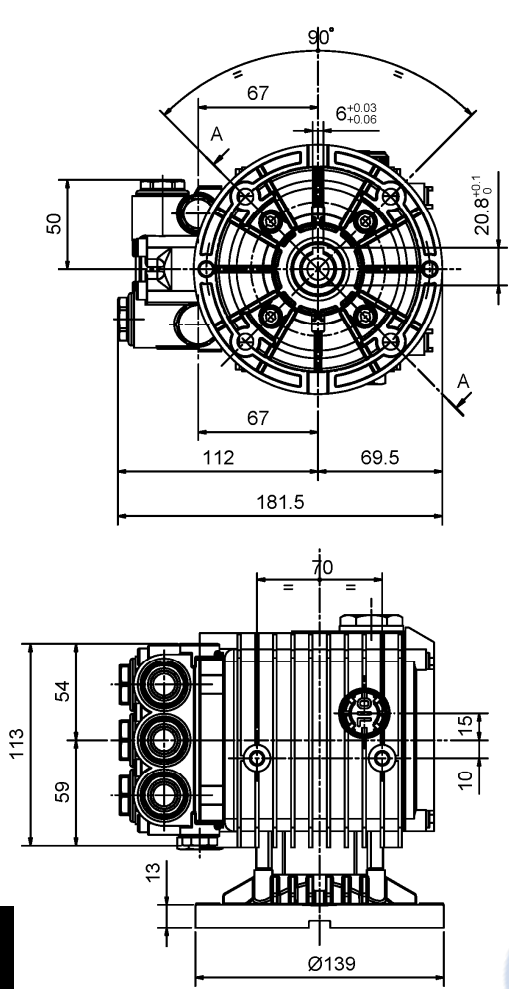

- W1507
- W1208
- W1210
- WW55 – TT551
- WW74 – TT471
- WW90 – TT901
- WW1508
- WW95 – TT951
- WW1510
- WW56 – TT561
- WW75 – TT751
- WW93 – TT931
- WW1511
- WW94 – TT941
- WW1513

COD. DIS. 51.2147.00

B

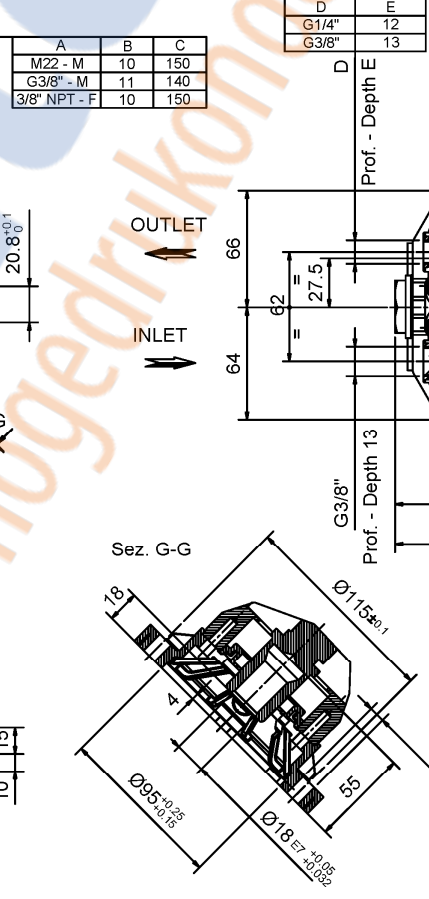
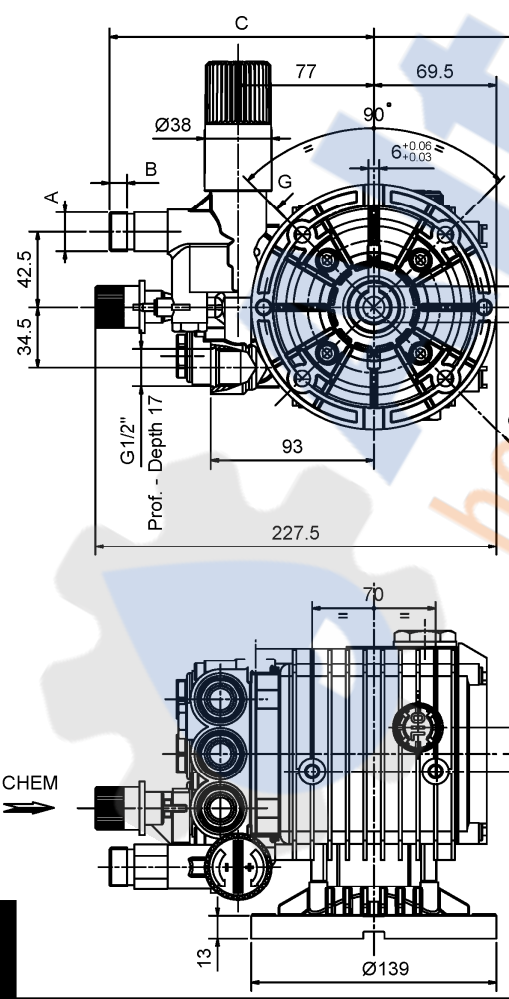

	A	B	C
M22 - M	10	10	150
G3/8" - M	11	10	140
3/8" NPT - F	10	10	150

D	E
G1/4"	12
G3/8"	13

COD. DIS. 51.2154.00

VH VALVE

B